

HANDLING, INSTALLATION, MAINTENANCE AND CARE INSTRUCTION GUIDE



Norscot Joinery Limited.
Bower Workshops,
Bower,
Wick,
Caithness
KW1 4TL

Please ensure that these instructions are followed at all times, failure to do so may invalidate your Norscot Joinery Limited guarantee.



1.0 Disclaimer

This document is supplied by The VEKA UK Group. Whilst we endeavour to keep information up-to-date, elements of this document and the information contained within it may be subject to change. The VEKA UK Group reserves the right to alter any specification or design without prior notice.

Any information, including text, diagrams and photographs contained in this document are for general information purposes only and are provided entirely at the user's risk. You should apply your own judgment in making use of any content, including, without limitation, the use of any information contained therein as the basis for any decisions. The VEKA UK Group shall not be responsible or liable, directly or indirectly, in any way for any loss or damage of any kind incurred as a result of, or in connection with the use of, or reliance on, any such information contained herein.

The copyright© of this document is the property of the VEKA UK Group and all rights are reserved. This document may not be copied in whole or in part or used for any other purpose than for which it was supplied without the prior consent of the VEKA UK Group.

Compliance with Health and Safety, local Building Regulations or other legislation are not covered as part of this document.

Please ensure that these instructions are followed at all times, failure to do so may invalidate your VEKA UK Group guarantee.



1.0 DISCLAIMER2

2.0 CONTENTS3

3.0 HEALTH AND SAFETY4

3.1 Safety in use: windows4

3.2 Safety in use: additional requirements for doors5

4.0 HANDLING AND STORAGE.....6

5.0 PROTECTION.....7

6.0 SURVEY AND INSTALLATION8

6.1 General8

6.1.1 Removal of windows.....9

6.1.2 Removal of sub-sills9

6.1.3 Removal of 'box-sash' windows.....9

6.1.4 Structural bay windows.....10

6.1.5 Bearing plates10

6.2 New frame preparation10

6.2.1 Fixing details11

6.2.2 Drainage.....14

6.3 Installation of glass14

6.3.1 Window glazing packer positions14

6.3.2 Door glazing packer positions.....15

6.4 Site glazing and inspection15

7.0 CLEANING, MAINTENANCE AND SAFETY IN USE16

7.1 Vents and ventilation.....16

7.2 Internal condensation.....16

7.3 External condensation16

7.4 Cleaning17

7.4.1 PVC-U frames.....17

7.4.2 Glass.....17

7.4.3 Hardware17

7.5 Component replacement.....18

7.6 Maintenance.....18

7.6.1 General18

7.6.2 Making a complaint18

7.6.3 Casement window19

7.6.4 Tilt and turn window20

7.6.5 Vertical slider sash window21

7.6.6 Top Swing window22

7.6.7 Entrance door23

7.6.8 Sliding Patio doors24

7.6.9 Tilt and slide patio doorsoors25



3.0 Health and Safety

It is the responsibility of the organisation or person who is carrying out the handling, installation, maintenance and care of the finished manufactured window and door to ensure that they work in accordance with the latest requirements of the Health and Safety at Work Act.

In common with many activities, there are significant hazards associated with handling, installation, maintenance and care of PVC-U windows and doors such as (but not limited to) :-

- Working at height
- Use of and potential exposure to hazardous substances with the installation, maintenance and care process (e.g. asbestos)
- Safety glazing
- Use of electrically powered equipment
- Manual handling

Before undertaking any activity, the organisation/person should ensure that they familiarise themselves and are fully trained with all Health and Safety requirements. Following a risk assessment appropriate PPE such as hard hats, high visibility clothing, safety footwear, gloves and safety glasses should also be worn if deemed necessary. If in doubt employ the services of competent persons trained in the requirements of handling, installation, maintenance and care of PVC-U windows and doors.



3.1 Safety In Use: Windows

Provisions should be made at the design stage to ensure that windows/doors can be cleaned safely, through incorporating easy clean hinges for instance. Restrictors may also be a requirement on the grounds of safety.

Virtually any type of window can be produced in PVC-U, such as Casement, Tilt and Turn, and Top Swing. When choosing a particular type of window consideration should be given, for instance to the following:-

- Cleaning from inside, safety in use and maintenance. Norscot Joinery Limited recommends that the user familiarises themselves with the relevant Building Regulations/Technical Handbooks, BS 8213-1:2004 Windows doors and rooflights. Design for safety in use and during cleaning of windows, including door-height windows and roof windows and BPF Code of practice, which gives detailed guidance on the selection of appropriate styles and sizes. If fitted load bearing capacity of safety devices must also meet the requirements of EN 14351-1:2006+A1:2010 CLAUSE 4.8.
- Weather performance
- Security
- Safety in case of fire. It is important to ensure that means of escape in case of fire are provided. Ventilation. The Glass and Glazing Federation also produce guidance documents for incorporating ventilation into replacement windows.
- Safety glass.
- Very large opening lights can be manufactured. Refer to hardware manufacturer's recommendations and do not exceed these size and weight limitations or those stated in the relevant VEKA UK Group manufacturing manual.

3.2 Safety In Use: Additional Requirements for Doors

Virtually any type of door can be produced in PVC-U, such as single hinged, double doors, inward or outward opening, in-line sliding and tilt & slide. When choosing a particular type of door, consideration should be given, for instance to the following (including the requirements for windows given in the previous section) :-

- Access to buildings and the requirements of low thresholds and size of openings for wheelchair access.
- Safety in case of fire. It is important to ensure that means of escape in case of fire are provided. EN 14351-1:2006+A1:2010 also specifies that fitting of any emergency exit/panic hardware for a locked door on an escape route must comply with clause 4.10.
- The provision of additional security devices such as spyholes and chains need to be specified and agreed.



4.0 Handling and Storage

When transporting glazed or unglazed frames, they should be firmly secured in an upright position on clean resilient packing. This will help prevent scratching of the surface of the profile. Frames stored on site should be treated in the same way and should be carried securely and placed in position without heavy impact, do not rest, lower or drop frames on corners or edges as it may result in permanent damage.



Windows that are delivered pre-glazed should have the glazing packed to ensure correct operation and to minimise distortion and breakage. Windows which have had the frames and glazing delivered separately should be packed in accordance with the recommendations and the latest version of BS 6262 and BS 8213-4.



PVC-U has a high resistance to weather, corrosion, and most materials found on building sites. However, as it is possible to deliver PVC-U frames, including glass to the installer in a "completely finished" condition, care taken in transport, storage and handling will prove beneficial, thus ensuring a good installed appearance and customer satisfaction.

5.0 Protection



Windows produced from VEKA UK Group profiles are supplied with low tack protective tape to exposed internal and external faces. This protective tape on the PVC-U profiles should be left intact but **MUST** be removed upon completion of the installation, prior to perimeter sealing and final cleaning.

Note; this protective tape should not be exposed to direct sunlight for long periods either prior to or preceding installation as it may become difficult to remove.

During construction care should be taken to avoid contamination or staining to surfaces or operating mechanisms to installed PVC-U frames. Therefore good practice is to keep all opening lights closed wherever possible, where this is not practical all operating mechanisms will require cleaning and may require lubrication before operation.

CEMENT, PLASTER AND SAND will not effect the properties of PVC-U and may be cleaned easily from the frame surface – though care should be taken to avoid scratching. They may block drainage channels and so these should be checked and cleaned carefully before handover. Cement and plaster will corrode and spoil the action of hardware and fittings so they should be cleaned off immediately.

TAR AND BITUMEN may stain the surface of white PVC-U and contact should be avoided during storage and installation



SILICONE SEALANTS generally will have no effect on PVC-U and may be used with confidence. However, mastic and sealant systems which include solvent based primers must not be used. If you are in doubt, consult the sealant supplier.

Check the structure around the openings for any defects such as cracked mortar joints and that suitable lintels are in place. Report any defects to the customer in writing and agree on the method of proceeding.

6.0 Survey and Installation

6.1 General

Norscot Joinery Limited promotes best practice with regard to the survey and installation of windows and external doors. These instructions should be used as a guide only. For more detailed instructions, **Norscot Joinery Limited** recommends that the installer familiarises themselves and works in accordance with British Standard, BS 8213-4:2007 Windows, doors and rooflights. Code of practice for the survey and installation of windows and external doorsets.

NOTE. PVC-U windows and doors are not designed to be load bearing.

Check the openings for any service cables (e.g. TV Aerial cables or telephone lines), mark these on the survey and agree with customer on the method of handling.

Determine the exposure category of the site and ensure that the replacement windows and doors are suitable.

Ensure compliance with Building Regulations or Technical Handbook as these affect both new buildings and refurbishment of existing buildings. Although replacement windows do not require an application to Building Control they must still comply with the current regulations. Particular attention is drawn to the requirements of Section 6 (Energy), Section 4.1 (Access to buildings) and Section 4.8 (Danger from accidents) of the current Technical Standards.

Also, the fitting of replacement windows and doors should not worsen the existing provision in respect of Technical Standards Section 3.14 (Ventilation) and Section 2.9 (Escape). Photographic evidence of existing windows and doors should be considered in respect of queries raised by inspectors etc.

Ensure there are no obstructions, either internally or externally, that will prevent the proposed windows or doors from functioning correctly (e.g. external rainwater pipes or internal taps).

Check that the design of product falls within the following recommended maximum size range.

In the event that protected species (e.g. bats, birds, butterflies, dormice) or plants that could be subject to special protection are found to be present, make a written record and seek professional advice before proceeding with any works. Also ensure that the building/homeowner is informed. Do not proceed with any works that is likely to disturb the species or its habitat unless cleared to do so by a qualified professional.

Take measurement of the width, height and diagonals as shown in Fig 1. The smallest measurement taken determines the right overall width & height sizes. The deductions shown in Table 1 (below) should then be made to allow for expansion and contraction of the new frames. Determine if projecting sub-sills are to be fitted and where included, ensure that a minimum projection of 25mm is provided beyond the structure. The difference between internal and external reveal sizes should be determined and checks made to ensure that the operation of any opening light will not be impeded by plaster, render, check relevel or tiles etc. The survey should also determine the installation method to be used (e.g. through the frame fixing or with fixing straps).

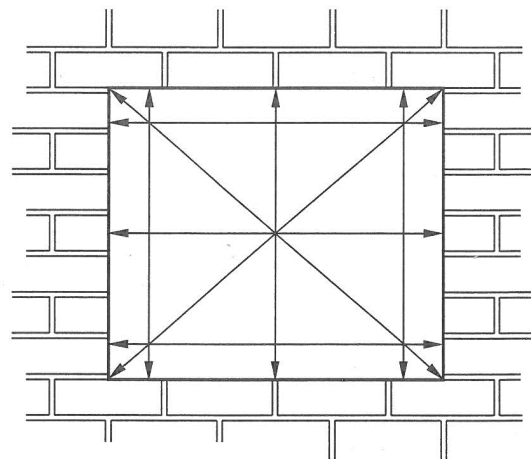

Fig. 1

Table 1.

Width/Height of opening	White PVCU	Non White PVCU
Up to 1.5m	10.0mm	15.0mm
1.5m to 3.0m	10.0mm	15.0mm
3.0m* to 4.5m	15.0mm	22.0mm
Over 4.5m*	20.0mm	28.0mm

These deductions are from the total width or height, and are not “per side”.

*Frames over 3.0m in any direction should incorporate expansion coupling.

When surveying a bay window, make a note of the materials above the window (e.g. brickwork, hanging tiles, tiled roof, etc.) as structural bay windows are required to have jacking poles to prevent any structural movement above the bay window (refer to section Structural Bay Windows for details). For all bay window installations, it is recommended that all bay window installations are load bearing unless there is evidence to prove otherwise.

6.1.1 Removal of Windows

Cover carpets and soft furnishings with dust sheets so as to minimise the possibility of damage

Remove all glass prior to removal of frame, glass must be removed with great care and appropriate protective PPE.

Remove sashes first, by either unscrewing the hinges or levering off with a crow bar. To avoid any damage internal decoration during removal of the frame, it is good practice to break the internal seal by running a knife between the frame and plasterline.

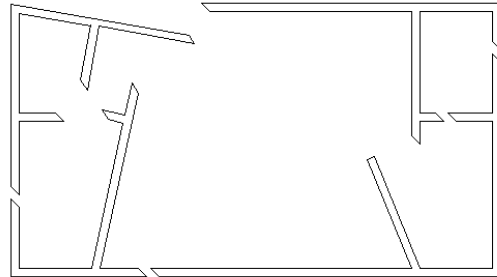

Make two cuts in all stiles slanted and distanced apart enough to insert the hoked claw of a crowbar.

This method of collapsing and folding the frame out of the opening is commonly used, and if carefully done reduces any damage to the internal/external finishes.

6.1.2 Removal of sub-sills

Sub-sills and heads are often ‘horned’ into the fabric of the aperture; great care must be taken when cutting and levering these items to reduce damage to plaster, renders and brickwork. If the DPC is damaged, it must be replaced prior to installation of new frame.

6.1.3 Removal of ‘Box-Sash’ windows

Many box-sash windows pre date cavity walls and are built into the internal reveals of solid brickwork. The sashes are removed fully glazed.

- Remove the mitred beading from around the frame.
- Cut the sash cords to release the weights.
- Remove the bottom sash, then take off the parting bead and take out top sash.
- Cut the outer frame from the aperture, leaving the horns in the structure.
- Remove the counterweights from the sash box.
- Remove the sub-sill, if this is not part of the outer frame.
- Remove the mitred beading from around the frame.

6.1.4 Structural Bay Windows

In order to maintain the structural integrity when replacing a bay window, it is essential that temporary supports are used. They must be placed in a position as to support without causing damage to ceilings or floors. In some cases support will be required externally as well as internally.

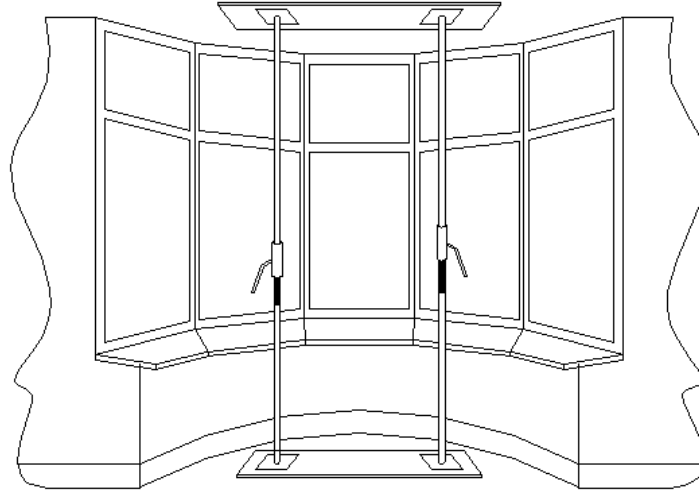

Checks should be made with your local building control department or seek the services of a structural engineer if you have any uncertainty regarding this area of an installation. For details on jacking poles see next section.

Please note: Some local authorities require Building Regulations approval when replacing any bay window.

6.1.5 Bearing Plates

Bearing plates should be made from steel with a minimum thickness of 3mm, or aluminium with a minimum thickness of 5mm. The area of the bearing plate should be an adequate area in order to spread the load and never any smaller than a minimum of 1800 sq.mm. Provision must be made to prevent the plate moving relative to the bay pole. The bearing plate must completely cover the end of the bay pole.

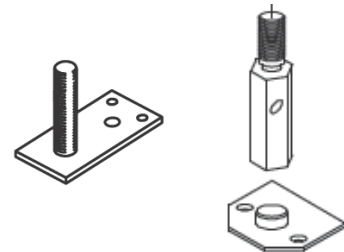

6.2 New Frame Preparation

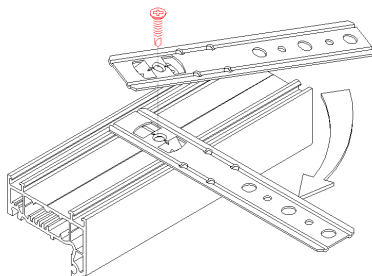

When preparing the new frame, the following points should be followed:

- If fixing brackets are to be used, these should be firmly attached to the outer frame.
- If you are to screw through the main outer frame into the structure, then the glass in the appropriate fixed light must be removed. If the window is too heavy for convenient handling, the glass units may also have to be removed.

Choosing one of the longest beads first, a paint scraper is pushed into the bead/frame joint at approximately the centre point. Apply force to lift the bead up and out, starting at the end of the next bead, the remainder can now easily be removed. Make a note of the positions of each bead to ensure correct positioning later.

6.2.1 Fixing Details

Frames can be fixed by any of the following methods. A minimum of 5mm clearance is required per side, to allow for packers at the fixing points, this will allow any movement in the structure etc.

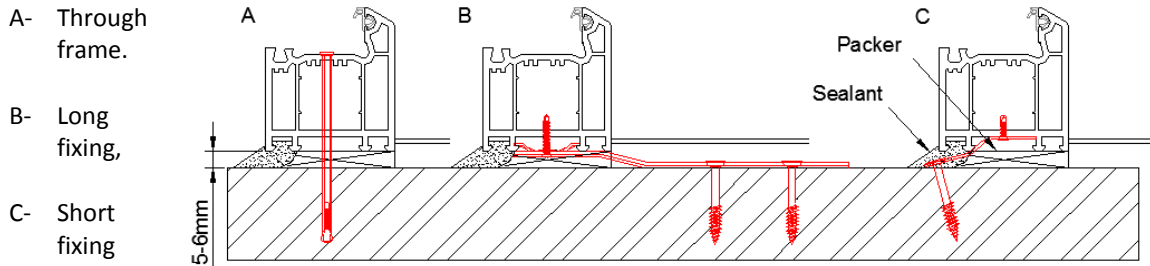

Prior to installation of the frames the damp proof membrane must be checked to ensure it is undamaged and still affective, any making good of the aperture should also be done including prevention of any cavity cold bridging.

A low modulus silicone must be used as well as backing rods as and when required. Exterior fixing lugs should be secured by "one-way" or other suitable screws. Expanding foam can only be used as an aid to mechanical fixings, and preventions must be put in place to stop any bowing of frames while being used.

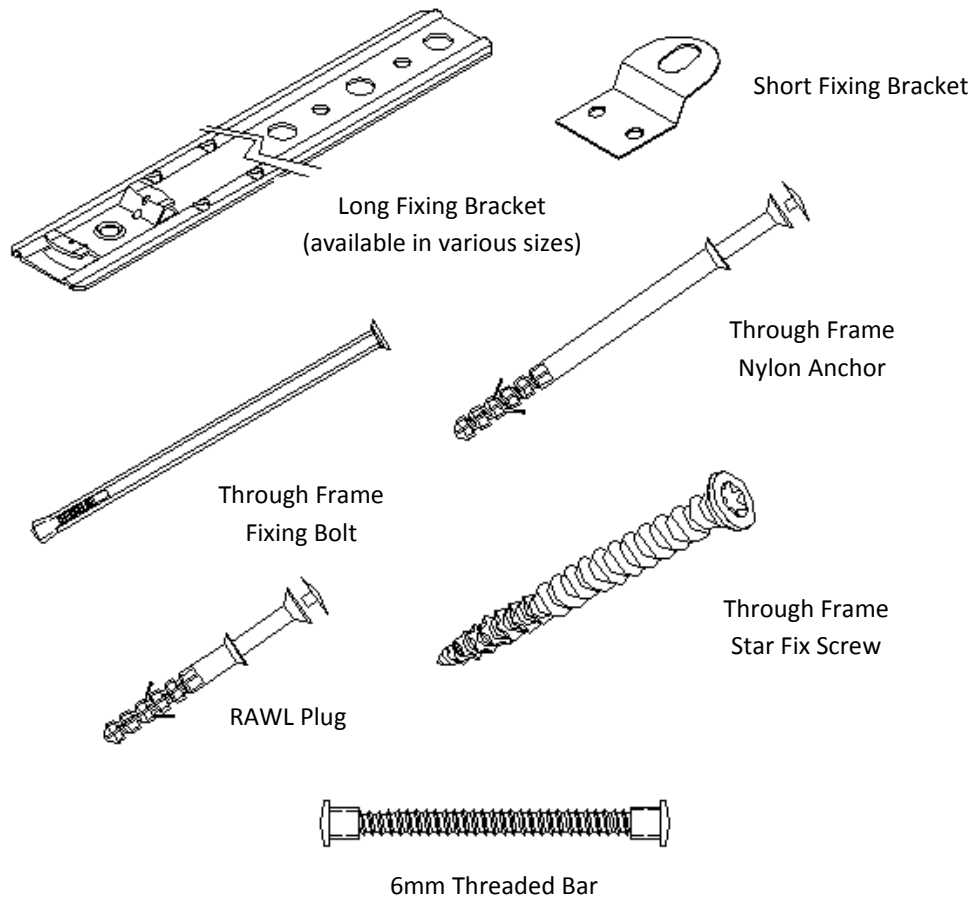

Fixings should be at least as corrosion-resistant as BS EN 1670:1998 Grade 3 and should penetrate the substrate a minimum distance of 50mm.

A minimum of 2 fixings per jamb must be achieved. The use of polyurethane foam is permitted where it is impractical to achieve mechanical fixing in the normal way but foam fixing is not acceptable as a sole means of fixing a frame.

Installation packers should be used adjacent to fixing positions to prevent outer frame distortion during installation. They should be resistant to compression, rot and corrosion. Over tightening of fixing should be avoided. When enhanced security is required, additional packers might be necessary adjacent to hinge and locking points.

If it is necessary to fix through the bottom member of the outer frame, where water can collect, adequate sealing over screw heads is recommended. Where possible, fixing brackets should be used for this application.

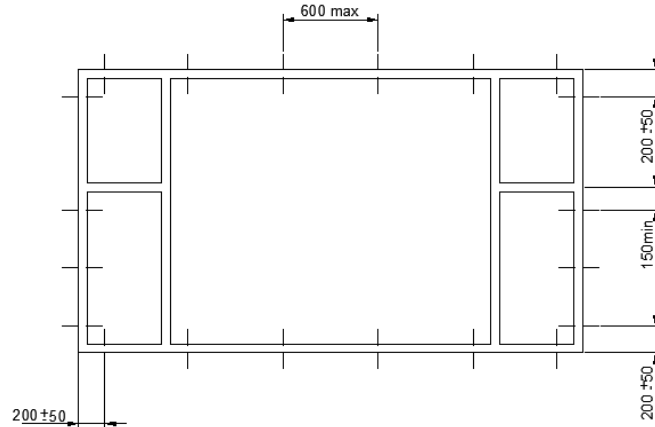

When installing PVC-U frames, care must be taken to make sure that the window or doors are fitted square and plumb.

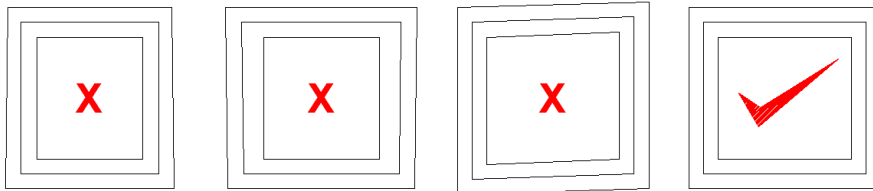

The following details provide indicative section details of the positioning of the frames within the reveal.

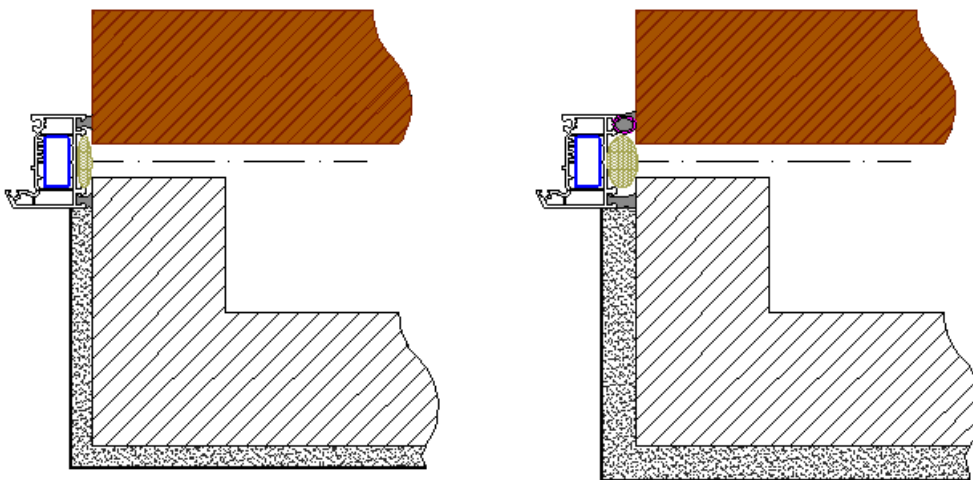

Flush reveal with joint width less than 6.0mm, frame bridging the DPM.

Flush reveal with joint width from 6.0mm to 15.0mm, frame bridging the DPM.

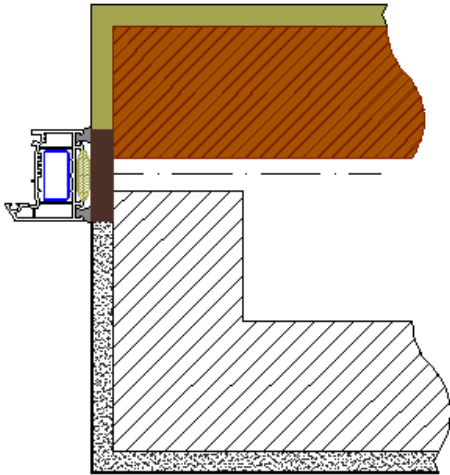

Flush reveal with external render, for replacement frames.

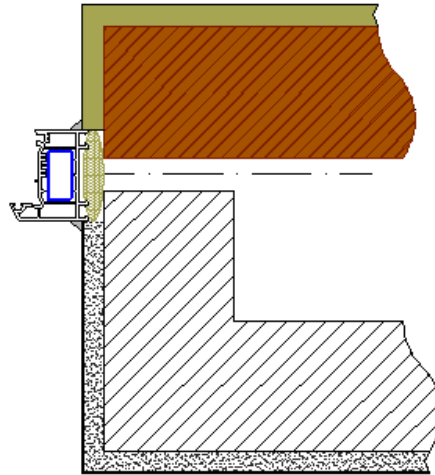

Flush reveal with external render, for replacement frame shuffled into position.

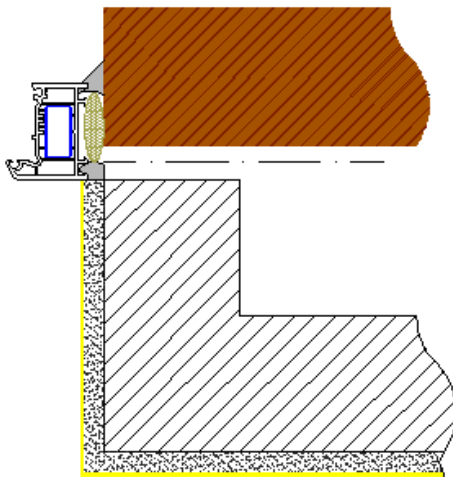

Frame forward of the DPM.

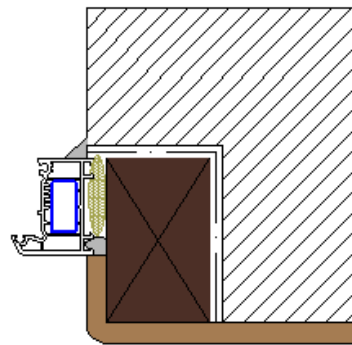

Box Sash replacement

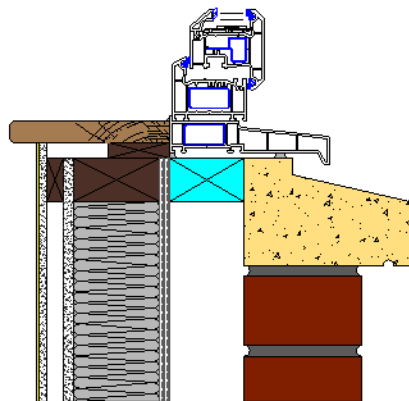

Typical new build sill detail.

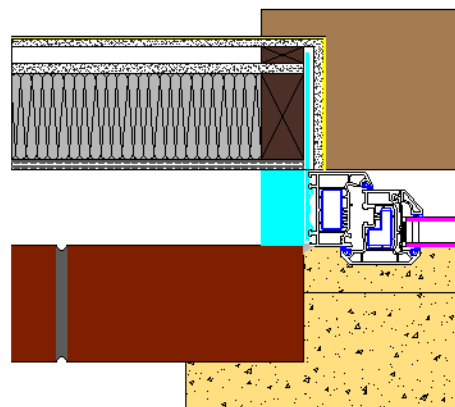

Typical new build jamb detail.

6.2.2 Drainage

It is essential that our recommendations for securing the glass in place are followed. Specifically, care must be taken to ensure that glazing blocks or spacers do not obstruct drainage of the water from the glazing rebate.

6.3 Installation of Glass

Prior to installing any glass unit or panel a clip in packer must be fitted into the glazing rebates of the frame or sash wherever the glazing unit has to be packed or spaced.

Always use packing blocks that are wider than the glass unit or panel, e.g. Unit 28mm wide, use a packer 30mm wide.

If glazing is completed whilst in the factory a small amount of silicone adhesive is to be applied to hold the packing blocks in position during transit.

Glass units must be installed clear of designated 'wet' areas in the framing and be packed to prevent opening lights from dropping.

6.3.1 Window Glazing Packer Positions

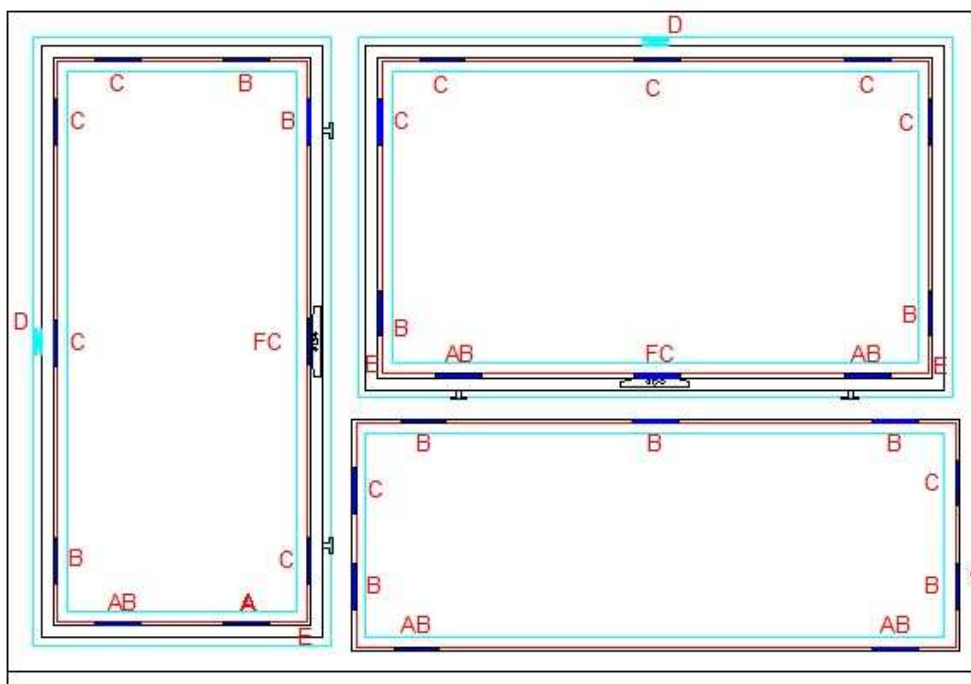

- A = Bridge Packer** Use on lower horizontal rails, min. 2 per rail. Position must not interfere with drain slots. Additional packers are required for lengths greater than 1500mm.
- B = Glazing Packers** Use to pack the glass unit into the apertures.
- C = Additional glazing packers** Position adjacent to locking points or cavity locking wedges in sashes and frames, and to space the glass on longer rails.
- D = Cavity locking wedges** 1 no. pair required for sashes when there length exceeds 800mm. When sash exceeds 1200mm, 2 no. pair are required.
- E = Run up blocks** Required for side hung sashes, may be fitted to top hung sashes for additional security.
- F = Locking Mechanism**

6.3.2 Door Glazing Packer Positions

A - Bridge Packer

Use on lower horizontal rails, min.2 per rail. Position must not interfere with drain slots. Additional packers are required for lengths greater than 1500mm.

B - Glazing Packers

Use to pack the glass into the apertures.

C – Additional Glazing Packers

Positioned adjacent to locking points in sashes and frames, and to space the glass on longer frames.

D - Door Multipoint Lock

E - Door Hinge

F - Run up block

G - Anti-lift blocks

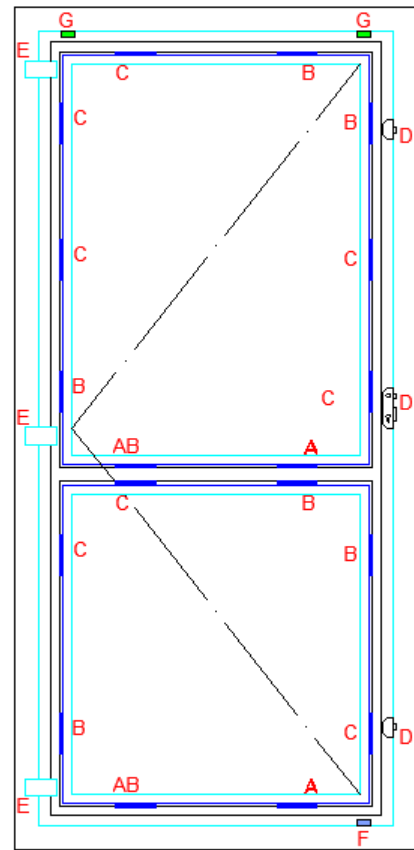

6.4 Final Inspection

Norscot Joinery Limited promotes best practice with regard to glazing. It is essential that site glazing is completed as per the recommendations set out. For more detailed instructions, **Norscot Joinery Limited** recommends that the installer familiarises themselves and works in accordance with the latest issue British Standard, BS 6262 Glazing for Buildings.

On completion of glazing, and the attachment of any special fittings, check the correct functioning of all windows and doors installed making adjustments where necessary. The protective tape on the framing can then be removed.

Apply a good quality low modulus silicone sealant to the joint gap between frame and structure on the outside. Care should be taken not to seal the drainage path for such as metal lintels. The 'Robust Detailing' methods referred to in the Building Regulations stipulate that an additional seal line is also placed to the inside gap between frame and structure on new build applications. The use of backing strips for gaps between 6mm - 15mm should be adopted, and the sealant manufacturer's guidelines followed.

Once installation is complete, a final inspection should be carried out, preferably with the purchaser to ensure that the installation is fully in accordance with the surveyor and manufacturer instructions. A final check list can be written and checked. Please ensure that the purchaser is aware of the operating methods regarding locking, unlocking and fire egress. If possible, it is good practice to ask the purchaser to sign off the installation after the inspection has been passed.



7.0 Cleaning, Maintenance and Safety in Use.

Your new **Norscot Joinery Limited** PVC-U windows and doors are designed manufactured and installed to the highest standards improving not only your home's appearance but making it more secure, warmer and more comfortable.

New PVC-U windows are extremely durable and long lasting and as a result will only require occasional cleaning and basic maintenance. By following these simple guidelines, they will give you years of trouble free use.

FAILURE TO FOLLOW THESE INSTRUCTIONS MAY INVALIDATE YOUR GUARANTEE

7.1 Vents and Ventilation

Your new windows will be much more efficient and draught proof than your old ones and as a result will prevent heat as well as moisture from escaping.

Where glazed-in or trickle vents are present in the window, they should remain open at all times even where they may be closeable via a shutter or pull cord. This will help prevent mould and condensation forming in the room and on the windows.

WARNING - It is imperative that vents remain open at all times in rooms where there are combustible appliances as to close them or block them up could lead to serious health and safety implications where carbon monoxide could be present.

7.2 Internal condensation

Condensation is caused by a number of factors and is affected by complex interrelationships between heat, moisture, air movement and building layout. The requirement for more efficient use of energy has led to increased levels of thermal insulation and airtightness in both new and refurbished buildings which in-turn can lead to an increase of condensation. This can be a particular problem in rooms where high humidity and water vapour is present such as kitchens and bathrooms. Additional items such as house plants, clothes drying and storage of fire wood can also have an effect.

Norscot Joinery Limited does not guarantee that its products will be free from condensation and does not accept liability for any loss or damage as a result. Condensation is caused by poor ventilation and not by double glazing but because of its superior insulating properties, can contribute to preventing it from escaping. Taking steps to control the amount of moisture created in a room is the most effective solution. Therefore ensure rooms are well ventilated by;

- Opening windows.
- Ensuring trickle vents remain permanently in the open position.
- Use exhaust fans whilst showering and cooking.
- Close doors to other rooms so that the moisture does not migrate.
- Reduce the amount of house plants in the room.
- Do not dry damp clothes in a room when it is not ventilated.



7.3 External condensation

Occasionally you may get condensation forming on the external pane of glass. This is usually visible on cold, clear mornings for instance in frosty weather. This phenomenon occurs because modern glass coatings and gas filled cavities have become so efficient at keeping the heat inside the room that warmth is not able transfer to the external pane to heat it up. This is not a product fault and as the daytime temperature rises the external condensation will disappear.

7.4 Cleaning

7.4.1 PVC-U Frames

The pristine appearance of PVC-U windows and door can be maintained by occasional cleaning. The frequency of this cleaning will depend on the local conditions, for instance, products installed in an industrially polluted or coastal area tend to require more frequent cleaning.

Generally the little maintenance which is required falls into two categories:

- Routine cleaning and maintenance that can be carried out by untrained personnel with no particular experience of PVC-U products.
- Repairs which can only be carried out by personnel with the requisite skills.

The cleaning of both gasket and profile sections should be carried out periodically to maintain the appearance. Failure to do this will not affect the performance of the products, but may spoil their appearance.

Stains that are not removable with soapy water may be removable using a domestic non-abrasive cream cleaner. However, these should not be used to excess as they can affect the gloss finish.

For PVC-U products with decorative finishes for example woodgrain foils, the supplier's advice should be sought on which products are suitable for use.

ON NO ACCOUNT SHOULD SOLVENT BASED CLEANERS BE USED.

PVC-U profiles never need painting, Should painting or repainting be desirable then this should only be undertaken by suitability qualified companies. The use of incorrect paint types can seriously damage the profiles.

Should any damage be found advice should be sought from suppliers or another suitability qualified professional.

7.4.2 Glass

Glass units should be cleaned with a good quality glass cleaner, again using a soft cloth or chamois leather and remains free of dirt or grit. Where glass has external coatings such as self-cleaning glass, please refer to the manufacturers guidelines.

7.4.3 Hardware

External hardware such as handles, hinges key cylinders, catches and restrictors have coatings and polished surfaces which can be restored by cleaning with a dry soft duster. Do not use water. Take care not to scratch surfaces with jewellery such as rings, keys or hang items from handles.

ON NO ACCOUNT SHOULD SOLVENT BASED CLEANERS OR MULTI PURPOSE LUBRICATES BE USED.

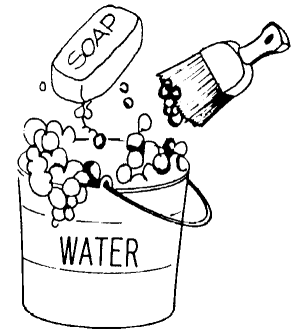

7.5 Component Replacement

Replacement components should only be fitted by trained personnel as the correct adjustment of the glazing, gaskets and hardware are critical to the performance of the window/door.

The frequency of replacement will depend on the environment, the level of care and maintenance and the frequency of opening and closing. It is likely that the PVC-U frames will outlast all other components, such as double glazed units and hardware. These items can be replaced by competent personnel. If a frame is scratched or damaged, it may be possible to affect a repair.

7.6 Maintenance

7.6.1 General

During routine cleaning it is advisable to check for damage such as abrasions, scratches, drainage paths clear of debris, signs of tampering and faulty operation of hardware. Should any damage be found advice should be sought from suppliers or another suitability qualified professional.

7.6.2 Making a complaint

Norscot Joinery Limited pride ourselves on the highest possible standards and will do our best to ensure that you never need to complain about our products or workmanship. However If you do have a complaint about the installation or performance of your new windows and doors, please inform us in writing; (even If you have initially made your complaint verbally or by telephone)

Write to;

Customer Services
Norscot Joinery Limited
Bower Workshops,
Bower,
Wick
Caithness
KW1 4TL

We will investigate your complaint and take the necessary action to resolve and rectify the issue to your satisfaction within a reasonable time frame.



7.6.3 Casement Window

Operation

There are many different locking and hinge options available these guidelines cover the most common multi-point espagnolette and shootbolt locking mechanisms and friction hinges. Casement windows usually incorporate two types of opening lights - top and side hung, both of which operate in the same way.



Opening and Closing

- Turn the handle 90° to release and push the window open. Some handles may have key locks or push buttons which must first be released.
- The friction stay hinge may limit the opening if incorporating a restrictor. Push the button to release the restrictor to allow the window to open fully. The friction hinge may also incorporate an easy-clean facility to facilitate safe cleaning. Never leave open windows unattended and always be sure to re-engage the easy-clean function as soon as cleaning has taken place, particularly where vulnerable people or children use the building.

Night Vent Facility

- Open the window as before but only by approximately 20mm so slightly ajar.
- Turn the handle back to the closed position taking care not to force it and you will feel the lock re-engage into the keeps. If the window has a key it can then be locked in this position.

Maintenance

- Ensure all moving parts are kept free and clear of obstruction. Do not trap or jam items in the window to prevent it from closing. If windows are too loose further adjustment to the windows can be made, this is done by tightening the brass screw located in each friction hinge.
- Lubricate all moving parts at least once a year with a light multi-purpose oil or acid-free lubricate (eg. Petroleum jelly) including the rivet points on stainless steel hinges. Do not use spray oil or acidic lubricant. To prevent excessive lubrication a lightly oiled cloth can be wiped around all moving parts.



7.6.4 Tilt and Turn Window

Operation

There are many different locking and hinge options available, these guidelines cover the most common multi-point espagnolette and shootbolt locking mechanisms. Always keep the window in the closed position when moving the handle and never pull on the window whilst turning the handle.

Opening from closed to tilt position and closing

- Turn the handle 90° from vertical to horizontal.
- For the tilt position, pull on the handle and the window will tilt inwards for ventilation.
- To close push the window forward and turn the handle 90° from horizontal to vertical.



Opening from closed to turn position and closing

- Close the window and turn the handle a further 90°, moving it through 180° to the upward vertical position.
- Pull on the handle and the window will open inwards.
- To close, push the window forward and turn the handle 180° to the vertical position.

Maintenance

- Ensure all moving parts are kept free and clear of obstruction. Do not trap or jam items in the window to prevent it from closing
- Lubricate all moving parts at least once a year with a light multi-purpose oil or acid-free lubricate (eg. Petroleum jelly). Do not use spray oil or acidic lubricant. To prevent excessive lubrication a lightly oiled cloth can be wiped around all moving parts.



7.6.5 Vertical Slider Sash Window

Operation

Opening from closed

- First release the sash lock(s) on the central meeting rail.
- Pull up the bottom sash or pull down the top sash using the handles.

Tilting inwards for cleaning



- Ensure the sash lock(s) is (are) released.
- Pull up the bottom sash approximately 50mm to clear the sill.
- Release the childproof spring latches in the top rail of the sash and carefully tilt inwards until the weight of the sash is supported by the restrictor arms.
- For the top sash, follow a similar procedure - pulling it down 300mm, releasing the spring latches and carefully tilting inwards.
- When closing from the tilt position, reverse the procedure starting with the top sash - ensuring that the spring latches fully engage in the side of the window.
- The tilting inwards of the sashes should be used only for cleaning purposes.



Maintenance

- Ensure all moving parts are kept free and clear of obstruction. Do not trap or jam items in the window to prevent it from closing.
- Lubricate all moving parts at least once a year with a light multi-purpose oil or acid-free lubricate (eg. Petroleum jelly). Do not use spray oil or acidic lubricant. To prevent excessive lubrication a lightly oiled cloth can be wiped around all moving parts.
- Note: The spring/coil balances are self lubricating and do not require oiling.



7.6.6 Top Swing Window

Operation

Always keep the window in the closed position when moving the handle and never pull on the window whilst turning the handle.

Opening from the closed position

- Turn the handle 90° from horizontal to vertical and push the window forward, it will click into a restricted open position of approximately 100mm. Some handles may have key locks which must first be released.
- Press the restrictor, located on the centre hinge to disengage, the window can now be fully opened.



Cleaning

- The window can also be fully reversed for cleaning. Once in the fully reversed position the restrictors will engage one again.
- When in the fully open position, if the pivot windows are too loose friction adjustment can be made by tightening the grommet located on the top of each hinge with an Allen key.
- To reverse the window back to its normal position, disengage the restrictor, located on the centre hinge and turn the sash back in the opposite direction. The restrictor may re-engage in the restricted position of approximately 100mm open. Release the restrictor again, pull the window back to the closed position and turn the handle through 90° from vertical to horizontal.



Maintenance

- Ensure all moving parts are kept free and clear of obstruction. Do not trap or jam items in the window to prevent it from closing
- Lubricate all moving parts at least once a year with a light multi-purpose oil or acid-free lubricate (eg. Petroleum jelly). Do not use spray oil or acidic lubricant. To prevent excessive lubrication a lightly oiled cloth can be wiped around all moving parts.



7.6.7 Entrance Door

Operation

These instructions are relevant for doors that open-inwards or outwards usually as entrance doors. These guidelines are primarily for when a lever handle is fitted on both sides of the door.

Unlocking and Opening

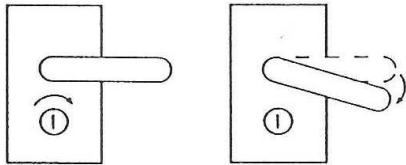

- Insert the key and turn it to unlock.
- Push the handle down and hold to disengage the locking components and open the door.

Closing and Locking

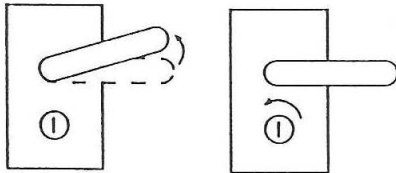

- Push or pull the door closed so that it clicks shut.
- Lift the handle up to engage the locking components.
- Insert the key, turn it to lock and then remove.



Maintenance

- Ensure all moving parts are kept free and clear of obstruction. Do not trap or jam items in the door to prevent it from closing
- Lubricate all moving parts at least once a year with a light multi-purpose oil or acid-free lubricate (eg. Petroleum jelly). Do not use spray oil or acidic lubricant. To prevent excessive lubrication a lightly oiled cloth can be wiped around all moving parts





7.6.8 Sliding patio doors

OPERATION

These instructions are relevant for irrelevant whether the sliding pane is internal or external.

Unlocking and opening

- Insert the key and turn it to unlock.
- The door is opened by operating the actuating lever to release the locking mechanism. By pulling the handle the door will slide sideways. Be careful not to slide the door too fast wide open on to its stop as this may cause the opening door to bounce and cause damage to its runners.

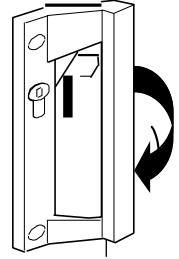

Closing and locking

- To close the door, reverse the process. Push the door gently into the closed position and throw the actuating lever to engage the locking mechanism.
- Insert and turn the key to lock.

Maintenance

- Ensure all moving parts are kept free and clear of obstruction. Do not trap or jamb items in the door to prevent it from closing. The track and running gear are liable to attract leaves and dirt and should be checked and cleaned out with a small soft brush on a regular basis or before use where there has been a long period of non-operation.
- Lubricate all moving parts at least once a year and the track at least twice a year with a light multi-purpose oil or a light acid-free lubricant (e.g. Petroleum jelly) Do not use spray oil or acidic lubricant. To prevent excessive lubrication a lightly oiled cloth can be wiped around all moving parts.



7.6.9 Tilt and slide patio doors

Operation

Unlocking and tilting

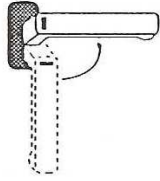

- Insert the key and turn to unlock.
- Turn the handle 90° from vertical to horizontal
- Pull the handle gently towards you and the door will tilt inwards for ventilation.



Sliding

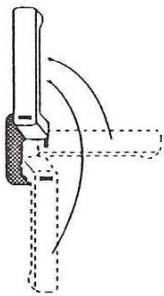

- From the tilt or ventilation position, gently push the door back to the closed position.
- Turn the handle a further 90° so that the handle is pointing to the upward position.
- Pull gently on the handle and the door will now slide open sideways.

Closing and locking

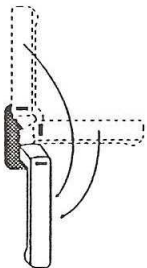

- From the open position, pull the door gently closed and turn the handle through 180°. This will engage the locking mechanism.
- Insert and turn the key to lock.

Maintenance

- Ensure all moving parts are kept free and clear of obstruction. Do not trap or jamb items in the door to prevent it from closing.
- Lubricate all moving parts at least once a year and the track at least twice a year with a light multi-purpose oil or a light acid-free lubricant (e.g. Petroleum jelly) Do not use spray oil or acidic lubricant. To prevent excessive lubrication a lightly oiled cloth can be wiped around all moving parts.

