



# Universal

TRADE FRAMES LTD

STANDARD SPECIFICATIONS (PVC WINDOWS & DOORS)



SUPPLIERS OF QUALITY FRAMES TO THE TRADE

# UNIVERSAL TRADE FRAMES ORDER PAD

## GUIDELINES

Please use the enclosed order forms to place orders. Quotes can be submitted on these forms and converted to order if required. Please tick clearly Order or Quote to indicate which you require.

Orders are to be emailed to [orders@uftl.co.uk](mailto:orders@uftl.co.uk). Quotes are to be sent to [quotes@uftl.co.uk](mailto:quotes@uftl.co.uk).

Use this specification guide alongside the order forms, as this will help you with the options that are available.

Frames will be manufactured to Universal standard specification as detailed in this document, unless otherwise stated.

It is important to complete delivery instructions and sign all orders. If there is no box for your requirement please use the comments and further information box.

All frames are to be drawn viewed externally, all sizes must be manufacturing sizes (it is recommended that a 5-10mm gap per side is allowed for) and include all frame extensions / cills / couplers. Items such as frame extensions, trickle vents and fire escape hinges can be drawn on your sketch.

Bays and conservatories must be measured to the internal cill and drawn as external view. A bay conversion from a flat to a bow bay is measured externally as a flat window with an internal projection. Deductions for poles and couplers will be done by Universal.

We will endeavour to eliminate mistakes however, with the best will in the world, mistakes can happen. Please always check your order acknowledgment for any mistakes made by either party and report any changes within 24 hours.

### Universal Trade Frames product list

- Casement Windows
- Flush Sash Windows
- Sliding Sash Windows
- Tilt and Turn Windows
- French Casement Windows
- Fully Reversible Windows
- Externally Glazed Windows
- Shaped Frames
- Residential Doors
- French Doors
- Stable Pvc Doors
- Doors with tilt and turn sash
- Solidoor Composite Doors
- Residoor Composite Doors
- Patio Doors
- PVC Bifolds
- Aluminium Windows
- Aluminium Doors
- Aluminium Patios
- Aluminium Bifolds

Specially designed order forms for all of the above products are available in the Downloads section of our website.

Please also visit our website for an extensive range of brochures and technical information. If you would like hard copies of any of these, please give us a call.

[www.uftl.co.uk](http://www.uftl.co.uk)

# STANDARD SPECIFICATIONS (WINDOWS)

## **OUTER FRAME - Spectus Elite 70 Ovolo B06 Intermediate outer frame as standard unless specified**

Other available options:

- Slim Outer Frame (B05) or Large Outer Frame (B07) available on request
- Bevelled B02 outer frame also available on request

## **BEAD - 28mm Ovolo bead (B62) as standard; 40mm Bevelled bead (B55) fitted when triple glazed. Internally glazed**

Other available options:

- 28mm Ovolo (B60) / 28mm Bevelled (B50) / 40mm Bevelled (B55)
- Externally Glazed available on request complete with glazing clips

## **REINFORCEMENT – Steel reinforcement to the Spectus System recommendation**

### **LOCKING - Elite TSL twin cam espag with night vent facility**

Anti Jemmy locks are available (used as standard on Secured By Design)

### **HANDLE - White cranked Fab and Fix key locking handle as standard**

- Other available colours: Gold / Chrome / Black / Satin / Bronze / Graphite
- Other available styles: Monkey Tail / Pear Drop

### **CILL - 150mm with base drainage as standard; A no cill request will be face drain unless stated**

Other available options:

- 85mm Stub / 110mm / 180mm / 225mm (available in all colours)

### **TRICKLE VENT - Greenwood vents fitted to the sash unless stated—available in white, brown and tan**

- Trickle vents can be fitted to the head if ordered with large head.
- Other colours are available using an Easy Vent

### **HINGE - Elite Range standard hinge fitted unless stated**

Other available options:

- Fire hinge 90° / Egress easy clean / Restrictor / Tristay (restricted egress) / Separate Hook and Eye restrictor

### **GLASS - 28mm A Rated low E, black thermal spacer, argon filled as standard**

Other available options:

- 28mm C Rated, silver spacer, argon filled (other spacer colours available on request)
- 40mm Triple Glazed A+ Rated, Black thermal spacer, argon filled
- Other WER ratings and glass options available on request
- “Secured By Design” Available
- All variations of Lead / Georgian and factory fitted Astragal bar available in all colours

**TILT & TURN WINDOWS - standard spec, using Ovolo Large Outer Frame (B07), face fixed GU gearing with a key locking handle with the facility to tilt only. Restrictors available on request. Concealed gearing available on request**

**FRENCH CASEMENT WINDOWS – fitted with 90° hinges as standard. Elite shoot bolt locking. Master sash on right**

	MIN WIDTH	MAX WIDTH	MIN HEIGHT	MAX HEIGHT	STANDARD
OUTERFRAME	200	3000	200	3000	
SIDE HUNG SASH	350	764	350	1364	610 (Req. for Fire Escape)
TOP HUNG SASH	350	1264	350	1264	375

# STANDARD SPECIFICATIONS (DOORS)

**OUTER FRAME** - Spectus Elite 70 Ovolo B07 large outer frame as standard unless specified

- Bevelled outer frame (B03) available on request

**MIDRAIL** - 110mm Ovolo midrail (B24/25) which can accommodate a letterbox; Standard height 850mm

**BEAD** - 28mm Ovolo bead (B62) as standard; 40mm Bevelled bead (B55) fitted when triple glazed. Internally glazed

Other available options:

- 28mm Ovolo (B60) / 28mm Bevelled (B50) / 40mm Bevelled (B55)

**REINFORCEMENT** - Steel reinforcement to the Spectus System recommendation

**LOCKING** - Elite 7 Point 2 hook 4 Roller Adjustable Cams, Yale silver anti bump/pick/drill cylinder

Other available options:

- Upgrade to Ultion cylinder

**HANDLES** - Fab and Fix White Lever/Lever. 2 x handles to French doors

Other available colours (all available as lever/lever (optional split spindle) or Lever/Pad)

- Gold / Chrome / Black / Satin / Bronze / Graphite

**CILL** - Availability as per window specification

**THRESHOLD** - PVC 70mm standard threshold

Other options available:

- Low PVC 50mm / Low aluminium - AM3 / AM5 / AM70 (available for open in and out)
- Internal ramps available on request

**HINGE** - White Trojan Patriot Flag Hinge

Other colour options:

- Gold / Chrome / Black / Brown / Tan

Other options available:

- Barrel hinges in White / Black / Brown / Tan
- SFS hinges in above colours plus Anthracite / Chartwell / Cream / Toffee

**GLASS / PANELS** - As windows; Toughened glass as standard. Panels available in all colours; 4mm MDF Reinforced

**RESTRICTOR** - Fitted as standard to open out doors

**FRENCH DOORS** - 2 working handles, Elite compact 4 hook 4 roller with shoot bolts lock, Key alike cylinders

**STABLE DOORS** - standard outer frame, sash and bead, deadbolt lock and key winding operation

**TILT & TURN DOOR** - standard outer frame, sash bead and lock. Concealed gearing to sash. Midrail @ 1120mm

**PUSH PAD/PUSH BAR** - available on single and French doors. Midrail @ 916mm

	MIN WIDTH	MAX WIDTH	MIN HEIGHT	MAX HEIGHT	
SINGLE DOOR	500	1084	1900	2284	HEIGHTS CAN BE ADAPTED WITH ALTERNATE LOCK
FRENCH DOOR	1000	2094	1900	2284	AS ABOVE

# FLUSH CASEMENTS

## **OUTER FRAME - QS02 sculptured outer frame welded as standard**

- Mechanically jointed outer frame available

## **SASH - QC32 Sash Welded as standard. Mechanically jointed available**

- Dummy sashes as standard to all non opening apertures
- Co-extruded gasket and centre wool pile
- QC34 Deep bottom rail (only available as a mechanically jointed option)

## **BEAD - 24mm QS65 Ovolo bead as standard**

## **REINFORCEMENT - Steel reinforcement to the Spectus System recommendation**

## **LOCKING - Kenrick lock**

- Anti Jemmy is available (used as standard on Secured By Design)
- French casement style and night vent facility available

## **HANDLE - White cranked Fab and Fix key locking handle as standard**

Other available colours:

- Gold / Chrome / Black / Satin / Bronze / Graphite
- Monkey tail and authentic stays available in Black / Gold / Chrome / Graphite

## **CILL - 150mm with base drainage as standard; A no cill request will be face drain unless stated**

Other available options:

- 85mm stub / 110mm / 180mm / 225mm available in all colours

## **TRICKLE VENT - Greenwood or Easy Vent (colour dependant) fitted to the sash**

## **HINGE - Elite Range – standard hinge fitted unless stated**

Other available options:

- Fire hinge 90° / Egress easy clean / Restrictor / Tristay (restricted egress) / Separate Hook and Eye restrictor

## **GLASS - 24mm A Rated low E, black thermal spacer, argon filled as standard**

Other available options:

- 24mm C Rated, silver spacer, argon filled (other spacer colours available on request)
- All variations of Lead / Georgian and Astragal bar available

	MIN WIDTH	MAX WIDTH	MIN HEIGHT	MAX HEGHT	STANDARD
OUTERFRAME	200	3000	200	3000	
SIDE HUNG SASH	350	764	350	1364	610 for FE
TOP HUNG SASH	350	1264	350	1264	375 DROP

# STANDARD SPECIFICATION (BAY WINDOWS & CONSERVATORIES)

Frames as per standard specification

Sizes to be provided as internal size (exception: bow window) viewed externally

Maximum height of a bay window (without requiring structural calculations) = 2500mm

## **REINFORCEMENT - Steel reinforcement to the Spectus System recommendation**

**BAY POLES: Round bay pole (B70) complete with adaptor (B74), steel reinforced**

**Square bay corner post B271, steel reinforced, used for 90° welded cills**

**135° corner post BR279, steel reinforced complete with B278/B279 capping used for 135° angles**

Other available options:

- BR270 Fluted Square corner post
- BR277 135° fluted corner post, steel reinforced complete with B276/B277 capping
- BR280 Variable fluted corner post, available for angles between 120°-170° 5 piece post with capping
- Load bearing kits available on request used with a round bay pole or square

## **GLASS - Toughened Glass will automatically be applied to the bottom units of a conservatory**

### **How to order your welded cill**

#### **Bay Window:**

Sizes of each segment measured internally from existing plaster line to centre of existing pole

Internal angle of each segment

#### **Bow Window:**

External opening size brick to brick (allowing for clearance)

Projection from plaster line to inside of new bow window

#### **Conservatory:**

Measured to the internal cill

## ANCILLARIES FOR WINDOWS AND DOORS

See enclosed ancillaries chart

### **FRAME EXTENTIONS - 20mm (B78) as standard**

Other available options:

- 15mm (B77) / 35mm (B79) / 50mm (B80)

### **COUPLERS - 3mm SWR748 with SW55 cover caps both sides**

Other available options:

- 9mm aluminium BR276 with fluted cover caps
- 2.5mm SW754 H Bar
- 29mm B273 reinforced with heavy duty steel
- Expansion couplers available

### **HEAD DRIP - SW740 available in white / rosewood / oak**

# PATIOS

**OUTER FRAME** - Spectus SW263 70mm outer frame

**SASH** - Spectus SW264

**MIDRAIL** - SW268 150mm midrail, accommodates a letterbox (midrail available upon request)

**BEAD** - SW266 28mm internally glazed

**REINFORCEMENT** - Steel reinforcement to the Spectus System recommendation

**LOCKING** - Winlock 6 hook lock with one piece keep. Yale Cylinder (upgrade to Ultion available)

**HANDLE** - White patio handle

Other available colours:

- Gold / Chrome / Black

**CILL** - 150mm as standard, availability as per window specification

**THRESHOLD** - PVC 70mm standard threshold

**TRACK** - External slide as standard

Other available options:

- Internal slide available

**GLASS / PANELS** - 28mm A rated as standard

**ANCILLARIES** - 15mm / 20mm / 50mm frame extensions available on request

OPTIONS	MIN WIDTH	MAX WIDTH	MIN HEIGHT	MAX HEGHT	Mechanical Jointed Available
2 PANE	1490	3000	1400	2400	
3 PANE	2230	4400	1400	2400	
4 PANE	2890	4600	1400	2400	

# VERTICAL SLIDERS

## **OUTER FRAME - Spectus VS01 128mm**

## **SASH - VS03/VS04 standard 60mm sash**

Other available options:

- VS05 90mm deep bottom rail

## **BEAD - VS06 Square bead**

Other available options:

- VS07 Ovolo Bead

## **REINFORCEMENT - Steel reinforcement to the Spectus System recommendation**

## **HANDLE - White Key Locking Fab and Fix fully suited hardware**

Other available colours:

- Gold / Chrome / Satin / Black

## **CILL - Integrated VS42 150mm**

Other available options:

- VS14 210mm

## **FRAME EXTENSION - A77 15mm / A78 30mm / A79 50mm available**

## **GLASS / PANELS - 24mm A rated as standard.**

Other options available:

- Factory glazed astragal bar 22mm VS11 in all colours
- Other glass ratings available

## **SASH HORNS - No horns will be fitted unless requested**

Mock or Run through available

## **CHILD RESTRICTORS/TRAVEL RESTRICTORS - Available on request**

## **FIRE ESCAPE - Available on request**

## **NIGHT VENT - Available on request**

## **Available Colours**

White

Rosewood

Oak

Anthracite Grey on White

Black Foil on White

All other Spectus colours available on extended lead times

# LEAD TIMES

See table below for available colours and lead times (working days)

Colour	Elite 70 Ovolo Lead Time	Elite 70 Bevelled Lead Time	Flush Casement Lead Time	Vertical Slider Lead time	Patio Lead Time
White	5 days	7 days	10 days	10 days	5 days
Rosewood on White	5 days	7 days	10 days	15 days	5 days
Rosewood*	5 days	7 days	10 days	15 days	5 days
Oak on White	5 days	7 days	10 days	15 days	5 days
Oak**	5 days	7 days	10 days	15 days	5 days
Anthracite Grey on White	7 days	10 days	10 days	15 days	20 days
Anthracite Grey*	7 days	10 days	30 days	30 days	30 days
Black Brown on White	7 days	10 days	10 days	15 days	20 days
Black Brown*	7 days	10 days	30 days	30 days	30 days
Cream on Cream (cream base)	7 days	10 days	10 days	15 days	30 days
White Foil on White Foil	7 days	10 days	10 days	15 days	20 days
Irish Oak on White	20 days	20 days	20 days	20 days	20 days
Irish Oak**	30 days	30 days	30 days	30 days	30 days
Chartwell Green on White	20 days	20 days	20 days	20 days	20 days
Chartwell Green	20 days	20 days	20 days	20 days	20 days
Classic / Premier range on white base	20 days	20 days	20 days	20 days	20 days
Classic / Premier Range on Brown or Tan base	30 days	30 days	30 days	30 days	30 days

White base

\*Brown Base

\*\* Tan Base

## **Classic Range**

Dark Red  
 Brilliant Blue  
 Steel Blue  
 Dark Green  
 Signal Grey  
 Basalt Grey  
 Anthracite Grey Smooth  
 Hazy Grey  
 Natural Oak  
 Rustic Oak  
 Chartwell Green  
 Slate Grey  
 Mahogany  
 Agate Grey  
 Swamp Oak  
 Walnut  
 English Oak

## **Premier Range**

Siena PR  
 Dark Oak  
 Irish Oak  
 An Teak  
 Cream on White  
 White foil on White

# GUARANTEE

Universal Trade Frames Limited operates a policy of adopting the highest standards in quality, in both the selection of individual components and the processes and methods used in the manufacture of their products.

As a direct result of this policy Universal Trade Frames Limited are pleased to pass on the following guarantees to our customer:

- Fabricated PVC-U window & door products - 10 year guarantee
- All fitted hardware - 10 year guarantee
- Double glazed units - 10 year guarantee

All guarantees are subject to correct installation in accordance with the recommendation set out by the British Plastics Federation & the Glass and Glazing Federation.

In consideration of a customer purchasing PVC-U fabricated products:

Universal Trade frames Ltd Guarantee, for a period of 10 years, the manufacture of its PVC-U products.

Universal Trade Frames Ltd Guarantee, against operational failure, for a period of 10 years, all hardware used during the manufacture of all products.

The hardware guarantee shall not apply if:

The product was not correctly fitted, adjusted and operated.

The product was subjected to stresses and operating forces beyond recommended levels or to any form of abuse.

The product was not correctly maintained and lubricated at least twice a year.

Corrosion is caused by exposure to salt spray.

Universal Trade Frames Ltd guarantee, for a period of 10 years, the optical and mechanical performance of their PVC-U window profiles used, within limits defined by the British Plastics Federation specification for high impact PVC-U hollow profiles. Provided they are maintained and installed in accordance with the BPF/GGF Trade Standard for PVC-U windows issued 2 January 1989 and all other current codes of practice.

Universal Trade frames Ltd guarantees such profiles for a period of ten years.

This guarantee shall apply only to defects appearing within the periods set out above from the date of manufacture provided that Universal Trade Frames Ltd is promptly notified in writing of such defects within those defined periods.

The sole and exclusive remedy with respect to the above guarantee or with respect to any other claim relating to defects or any other condition arising from the use of the products supplied by Universal Trade Frames Ltd, however caused, is limited to repair or replacement of such products at Universal Trade Frames Ltd' option.

Universal Trade Frames Ltd does not make any other representations or guarantees and in no event shall Universal Trade Frames Ltd be liable for any other loss or damage whether direct, indirect, special or consequential damages (including but not limited to the costs of reinstallation of the products).

Nothing in this guarantee shall exclude or restrict the liability of Universal Trade Frames Ltd for the death or personal injury resulting from its negligence in so far as the same is prohibited by Statute.

Nothing in this guarantee affects the statutory rights of consumers.

This guarantee is only applicable when the resultant windows, doors and other fabricated products are installed in the UK, Channel Islands or Eire.

Universal Trade Frames Ltd Terms and Conditions of Sale apply.

# PRODUCT GUIDE (70mm OVOLO PROFILE SUITE)

Ovolo is the standard profile you will receive unless otherwise requested

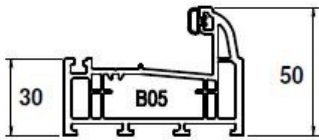

50mm  
Small Outer &  
Reduced Threshold

Standard (Windows)

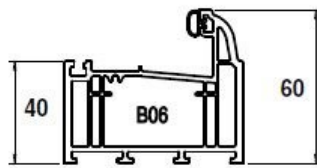

60mm  
Standard Outer  
(Casement)

Standard (Doors / T&T)

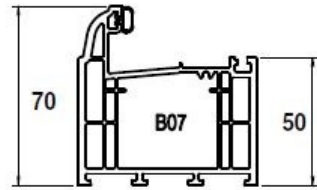

70mm  
Large Outer

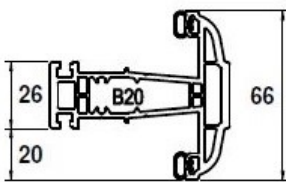

66mm  
Transom & Mullion  
Odd Leg Outer Frame

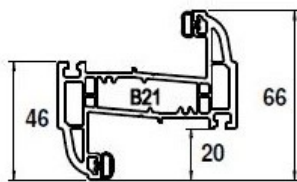

66mm  
Transom & Mullion  
Odd Leg Outer Frame

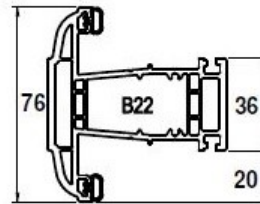

76mm  
Transom & Mullion

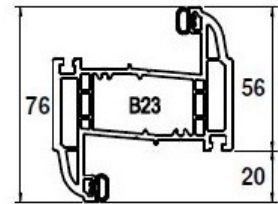

76mm  
Transom & Mullion

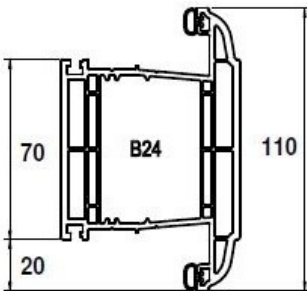

110mm  
Midrail & Mullion

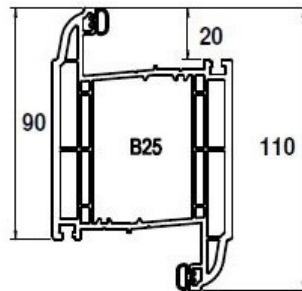

110mm  
Midrail & Mullion

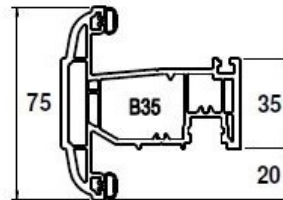

Internally Glazed  
Casement Sash

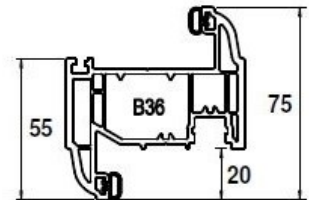

Externally Glazed  
Casement Sash

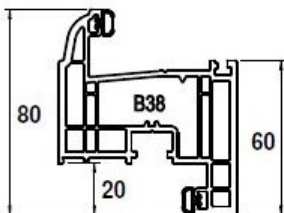

Tilt & Turn Sash

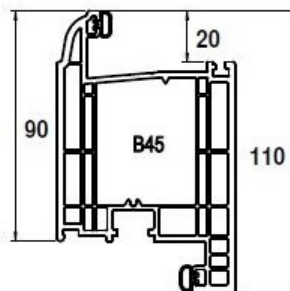

Door Sash

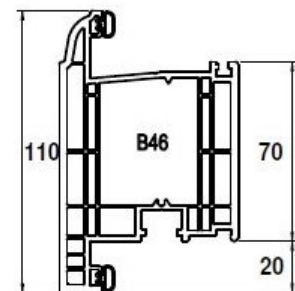

Door Sash



Standard  
(Double Glazed)

B62  
28mm BEAD



B60  
28mm BEAD



Standard  
(Triple Glazed)

B55  
40mm BEAD



# PRODUCT GUIDE (70mm BEVELLED PROFILE SUITE)

Ovolo is the standard profile you will receive unless you request Bevelled

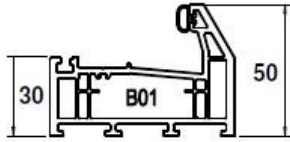

50mm  
Small Outer &  
Reduced Threshold

Standard (Windows)

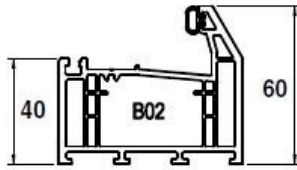

60mm  
Standard Outer  
(Casement)

Standard (Doors / T&T)

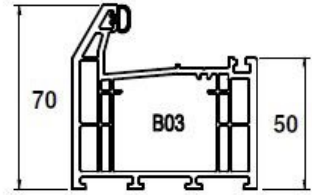

70mm  
Large Outer

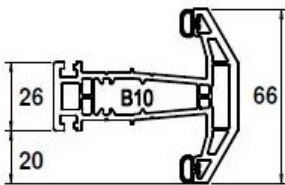

66mm  
Transom & Mullion  
Odd Leg Outer Frame

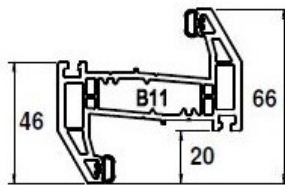

66mm  
Transom & Mullion  
Odd Leg Outer Frame

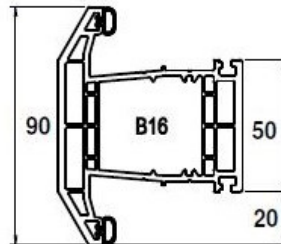

90mm  
Transom & Mullion

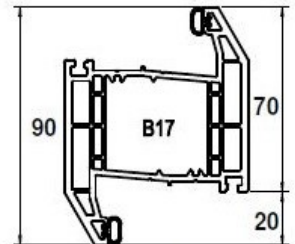

90mm  
Transom & Mullion

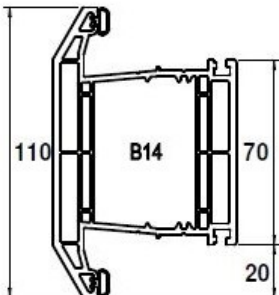

110mm  
Midrail & Mullion

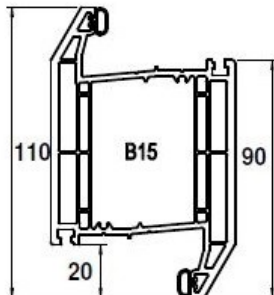

110mm  
Midrail & Mullion

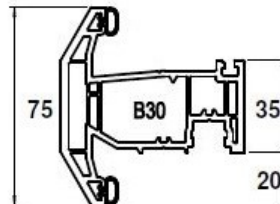

Internally Glazed  
Casement Sash

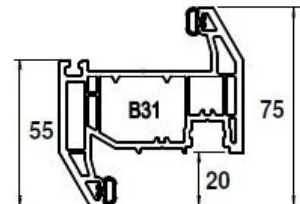

Externally Glazed  
Casement Sash

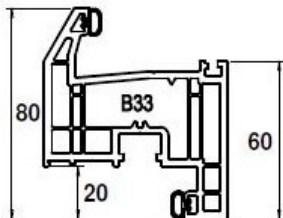

Tilt & Turn Sash

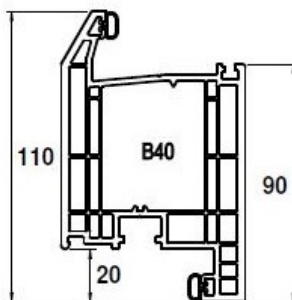

Door Sash

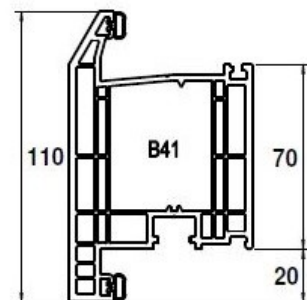

Door Sash

Standard (Double Glazed)

Standard



B50  
28mm BEAD

Standard (Triple Glazed)

Standard



B55  
40mm BEAD

**Spectus**  
WINDOW SYSTEMS

**ELITE 70**

# PRODUCT GUIDE (CILLS & CONNECTORS)

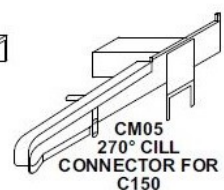
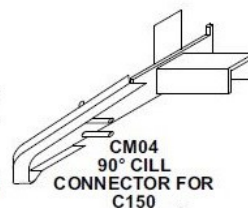
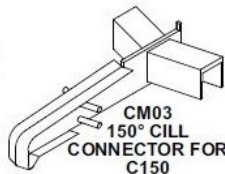
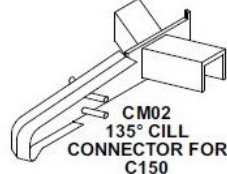
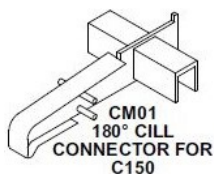
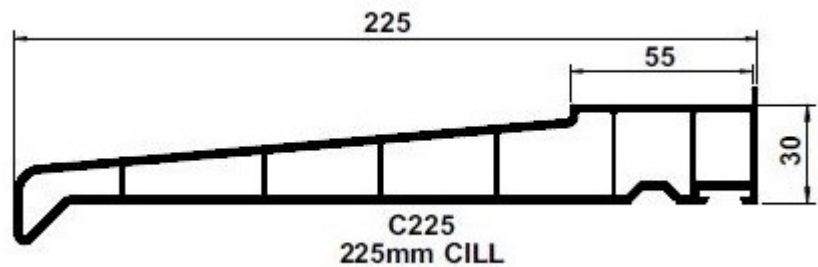
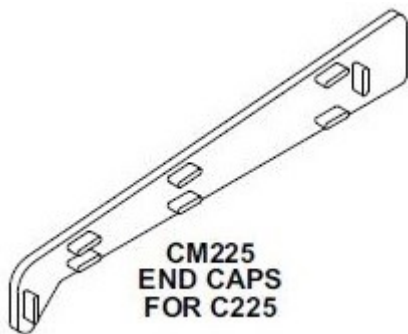
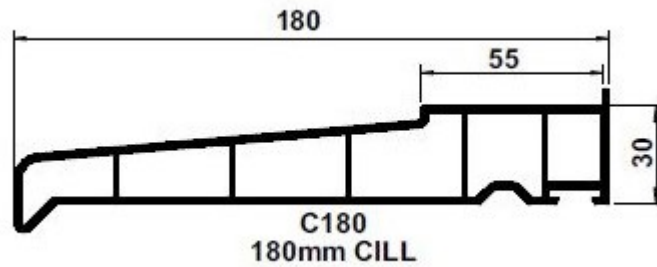
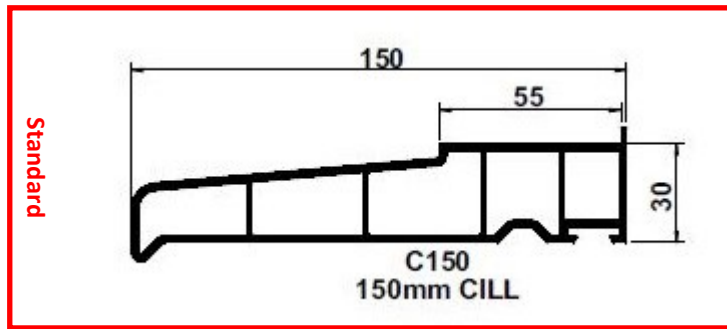
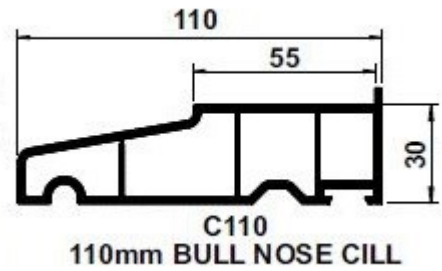
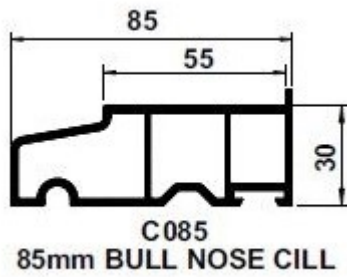

# PRODUCT GUIDE (LOW THRESHOLDS)

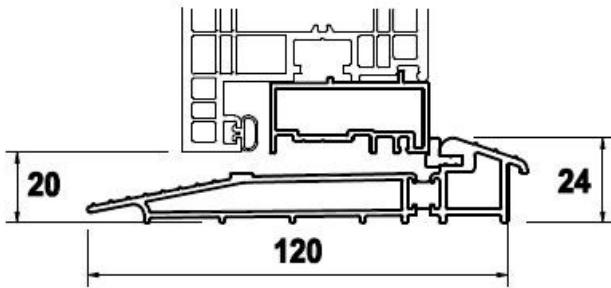

Open Out Low Threshold

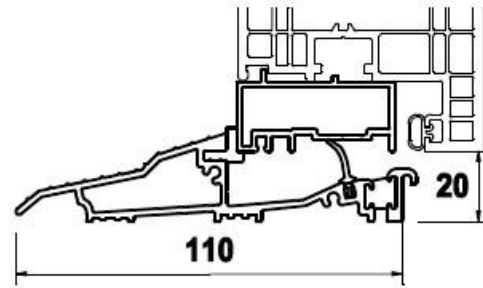

Open In Low Threshold

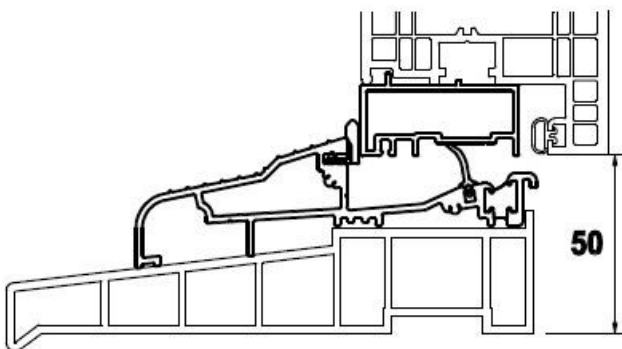

Open In Low Threshold On Cill

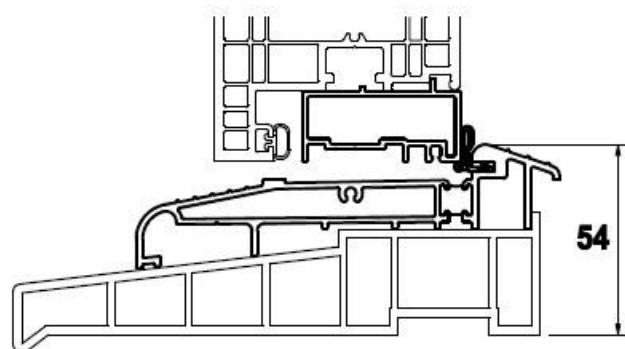

Open Out Low Threshold On Cill

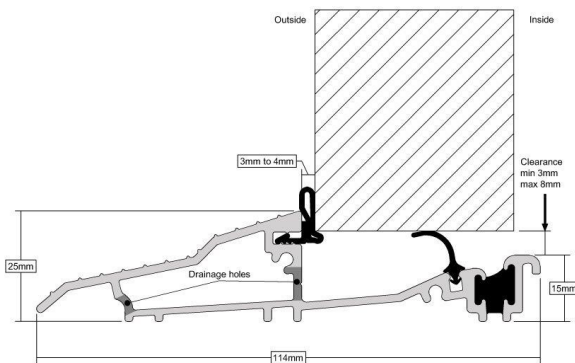

AM3 Open In Low Threshold

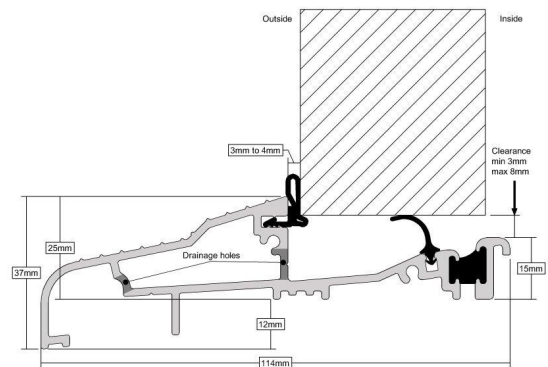

AM3 Open In Low Threshold On Cill

All thresholds are available in gold or silver

# PRODUCT GUIDE (EXTENSIONS & COUPLERS)

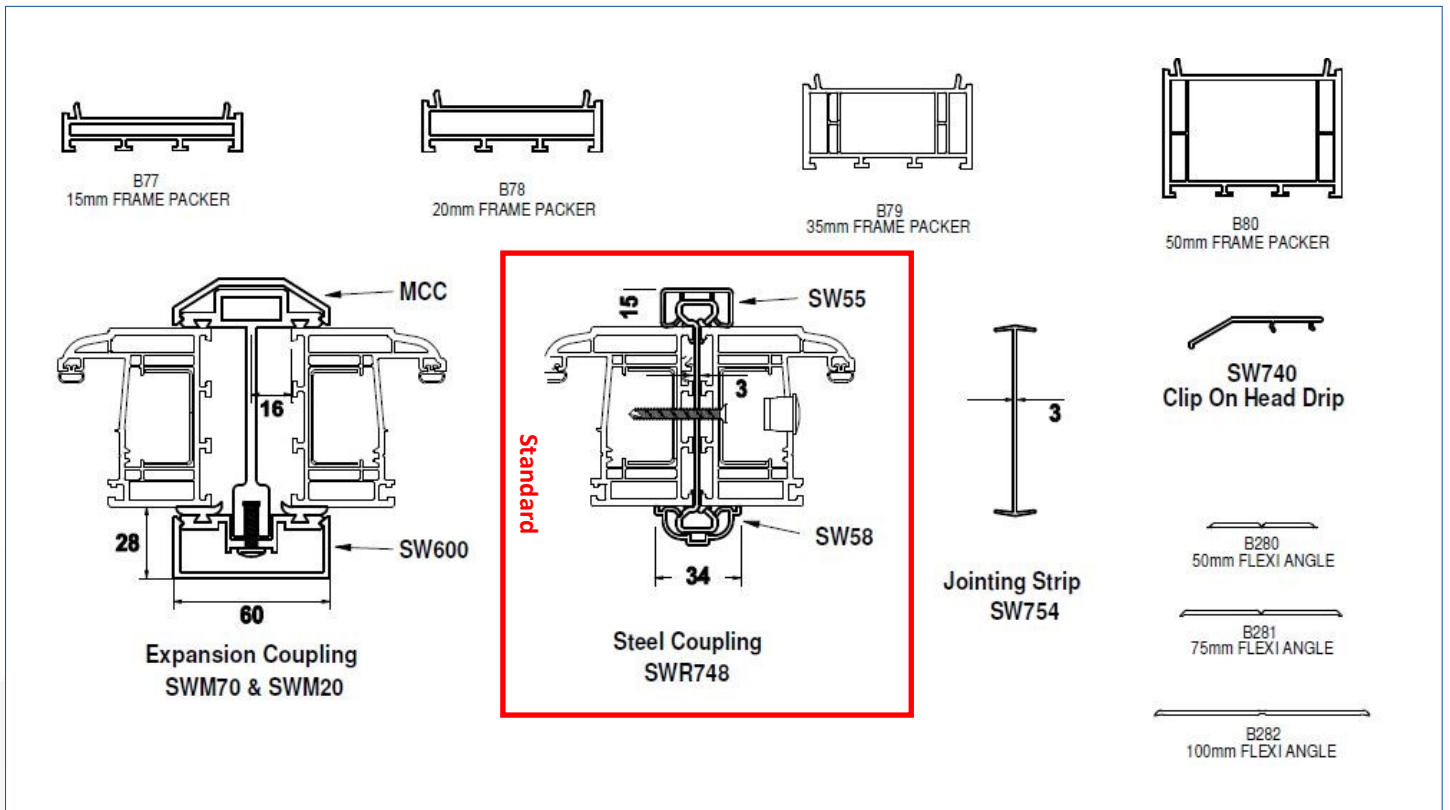

# PRODUCT GUIDE (RIDE OVER PATIO)

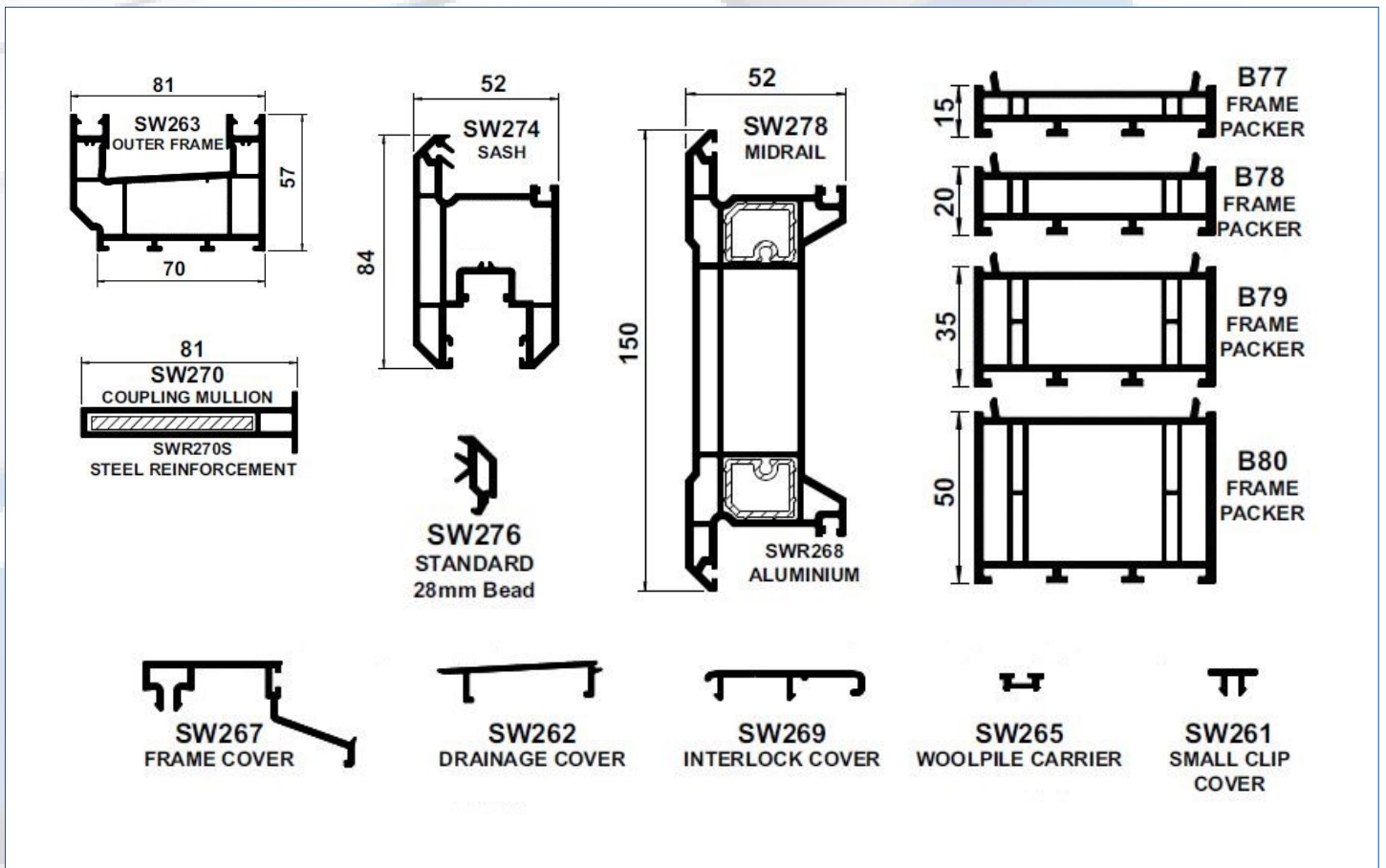

# PRODUCT GUIDE (70mm CORNER POSTS)

Standard (135-degree angles)

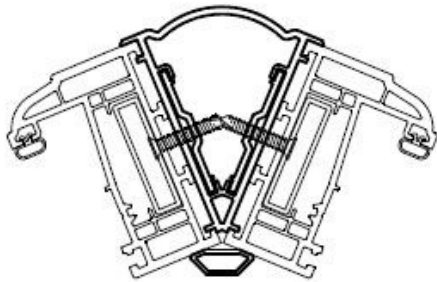

135° Bay Post  
Overlapping

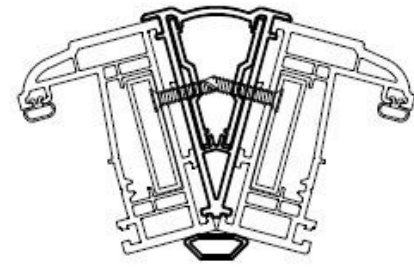

150° Bay Post  
Overlapping

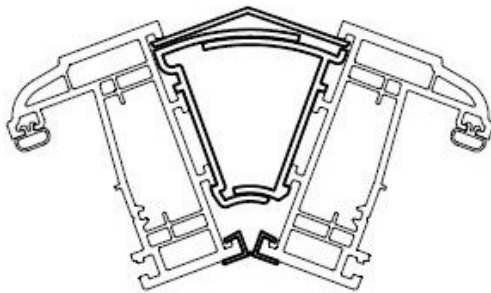

30° to 60°  
Variable Angle Post

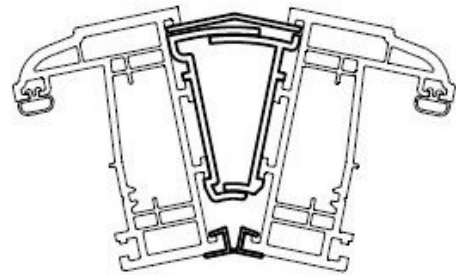

15° to 30°  
Variable Angle Post

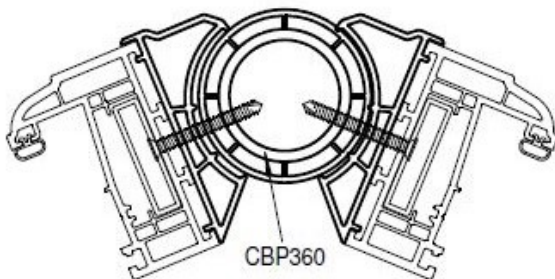

CBP360  
Round Bay Pole Assembly  
Structural

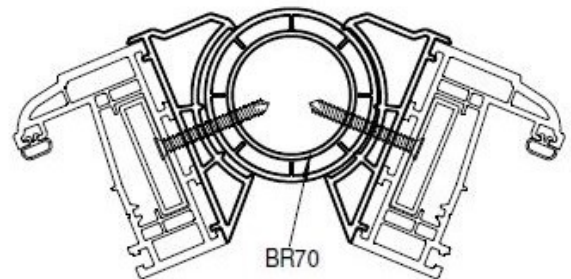

Standard (angles)

BR70  
Round Bay Pole Assembly  
Overlapping



BB75  
Bay Pole Jack

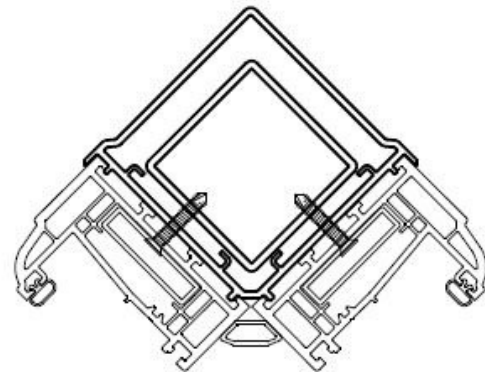

Standard (90-degree angles)

90° Bay Pole  
Overlapping

# PRODUCT GUIDE (70mm CORNER POSTS)

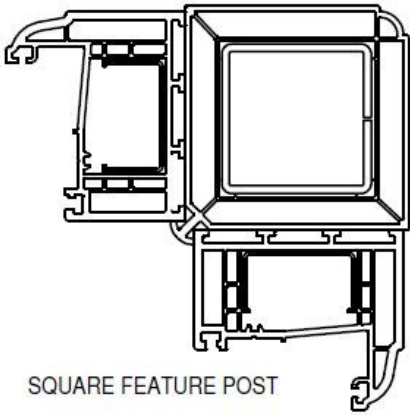

SQUARE FEATURE POST

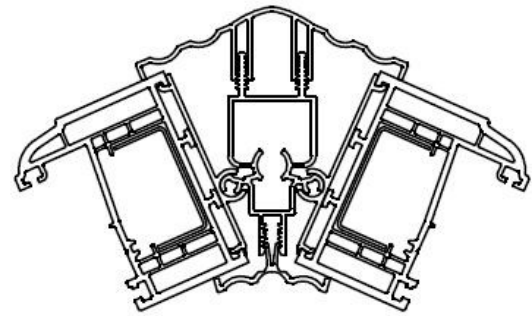

FLUTED VARIABLE POST  
120° - 170°

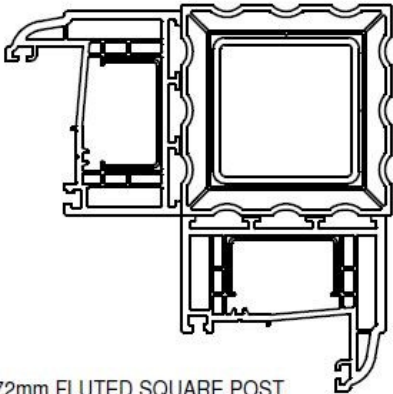

72mm FLUTED SQUARE POST

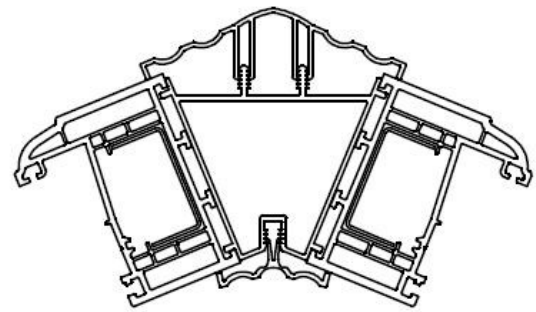

FLUTED FIXED ANGLE BAY POST  
135°

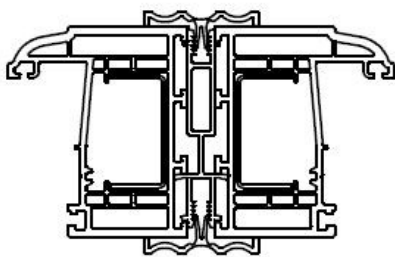

FLUTED COUPLING SECTION

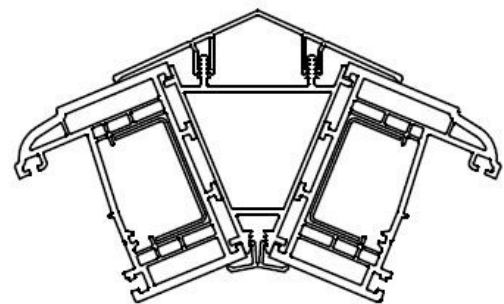

FLAT FIXED ANGLE BAY POST  
135°

# PRODUCT GUIDE (70mm FLUSH CASEMENT SUITE)

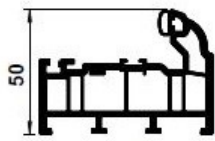

QS01  
OUTER FRAME

Standard

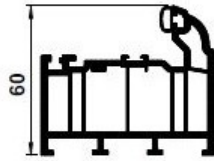

QS02  
OUTER FRAME

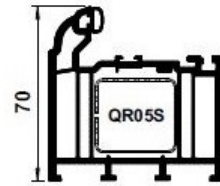

QS03  
OUTER FRAME

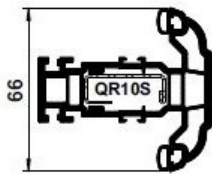

QS10  
'T' TRANSOM/  
MULLION

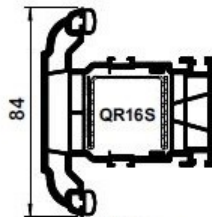

QS16  
'T' TRANSOM/  
MULLION

Standard

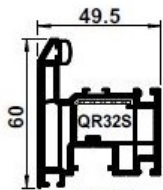

QC32  
SASH

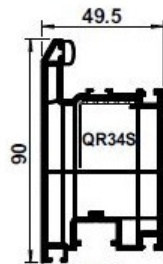

QC34  
DEEP BOTTOM RAIL

Standard



QS65  
24mm BEAD